

## Module – 5

### Structure

- 5.0 Introduction
- 5.1 Objectives
- 5.2 Cotton and textile industry
- 5.3 Tanning industry
- 5.4 Cane sugar and distilleries
- 5.5 Dairy industry
- 5.6 Steel and cement industry
- 5.7 Paper and pulp industry
- 5.8 Pharmaceutical and food processing industry.
- 5.9 Recommended Questions
- 5.10 Outcomes
- 5.11 Further Reading



### 5.0 Introduction

The fibers used in the textile industry may be groups such as cotton, wool, synthetic etc. The characteristics of the waste from the mill depends on the type of fiber used, as different types of fibers go through different sequences of operations before the woven cloth is sent out of the mill. The pollutants in the waste water include the natural impurities in the fibers used and the processing chemicals.

### 5.1 Objectives

1. Understand and design different unit operations involved in conventional and biological treatment process.
2. Apply the principles of Industrial effluent treatment process for different industrial wastes.

### 5.2 Cotton and Textile Industry

#### Manufacturing process

An integrated cotton textile mill produces its own yarn from the raw cotton. Production of yarn from raw cotton includes steps like opening & cleaning picking, carding, and drawing spinning, winding & warping. All these sequences are dry operations and as such do not contribute to the liquid waste of the mill. The entire liquid waste from the textile mills comes from the following operation of slashing (sizing), scouring, desizing, bleaching, mercerizing, dyeing & finishing.

In slashing the yarn is strengthened by loading it with starch or other substances wastes originates from the sections due to spills & floor washings. The substitution of low BOD sizes (such as carboxy methyl cellulose) for the high BOD of the mill effluent by 40 to 90%. After slashing, the yarn goes for weaving. The prepared cloth now requires scouring & desizing to remove natural impurities and the slashing compounds. Enzymes are usually used in India to hydrolyze the starch, acids may also be used for the is purpose. Caustic soda, soda ash, detergents etc. are also used in this section.

Bleaching operations use oxidizing chemicals like peroxides & hyper chloride to

remove natural coloring material. The section contributes about 10% of the total pollution load.

Mercerizing consists of passing the sloth through 20% caustic soda solution. This process includes the strength elasticity luster & dye affinity. Waste from this section is recycled after sodium hydroxide recovery. Negligible waste which may come out of this section contributes little BOD but a high degree of alkalinity.

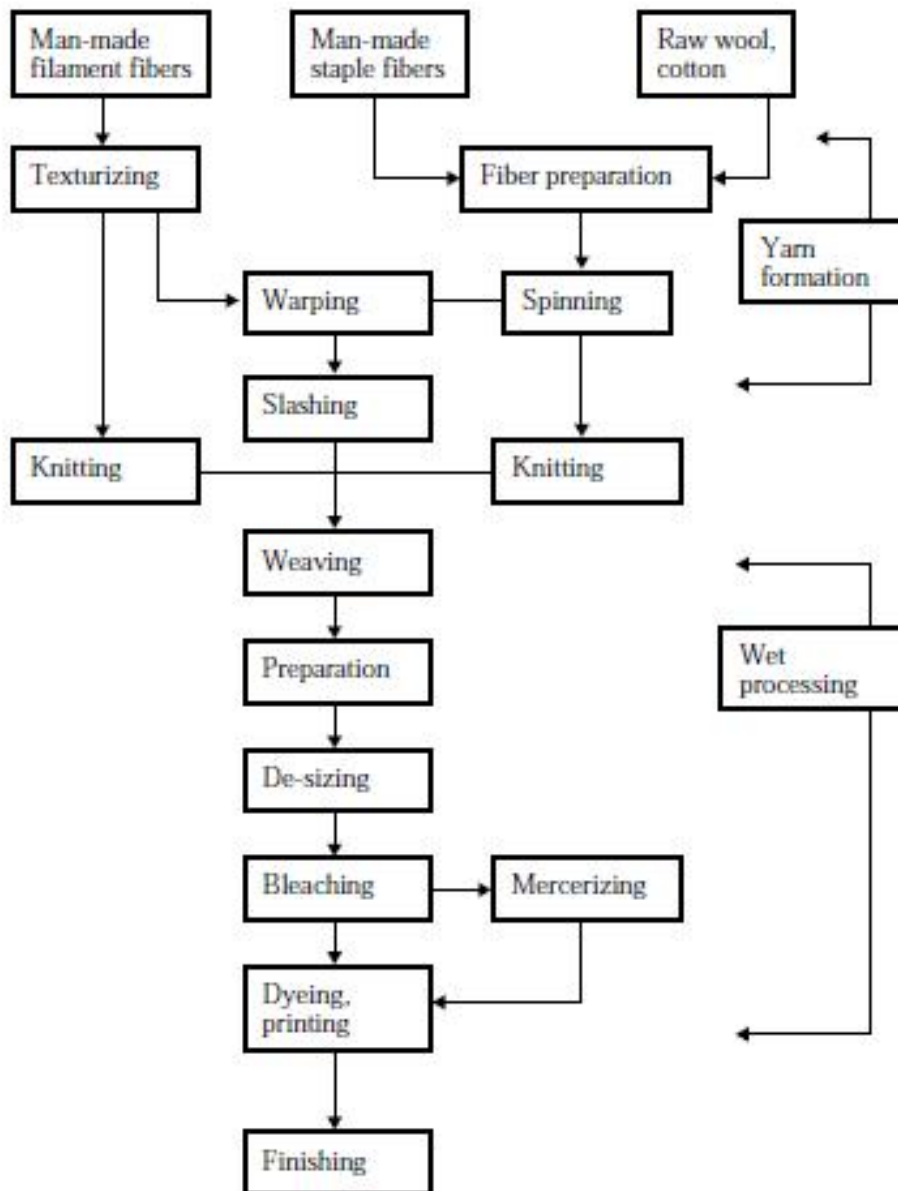

Dyeing may be done in various ways, using different types of dyes and chemical classes of dyes include Vat dyes, developing dyes etc. color from the dyes vary widely and although these are not usually toxic, they are treated separately. Thickened dyes are used for probing and subsequent fixation. After fixation of the prints, the fabric is given a thorough wash to remove the unfixed dyes. The finishing section of the mill imparts various types of chemicals are used for various objectives. These include starches, dextrans, natural & synthetic waxes, synthetics etc. Therefore a composite waste from an integrates cotton textile

mill may include the following organic & inorganic substances starch, carboxyl methyl cellulose, sodium hydroxide, detergents, peroxides, hyperchloride dyes & pigments, sodium gums, dextrans, waxes, sulphides, soap etc. Depending on the process & predominant dye used, the characteristics of the mill waste varies widely.

The characteristic of a typical Indian cotton textile mill is given below.

Characteristics	Value
pH	9.8-11.8
Total alkalinity	17.35 mg/lt
BOD	760 mg/lt
COD	1418 mg/lt
Total solids	6170 mg/lt
Total Chromium	12.5 mg/lt



### Effect of textile mill waste on receiving streams/sewers

If the mill waste water is discharged into streams, it causes depletion of DO of the stream. This is due to the settlement of the suspended substances and subsequent decomposition of the same in anaerobic condition. The alkalinity and toxic substances like sulphides & chromium affects the aquatic life and also interferes with the biological treatment processes. Some of the dyes are also found to be toxic. The color often renders the water unfit for use for side. The presence of sulphides makes the waste corrosive particularly to concrete structures. All treatment plants should be planned giving serious consideration for the reduction of waste volume & strength, through process of chemical substitution, chemical recovery & recycling of water. The pollution load from a textile, mill is dealt with operations like segregation, neutralization, equalization, chemical ppt, chemical oxidation & biological oxidation. Several chemicals are used to reduce the BOD by chemical coagulation such as alum, ferric sulphate, ferrous sulphate & ferric chloride, lime or  $H_2SO_4$  is used to adjust pH in this process. The dye waste may be economically treated by biological methods prior equalization, neutralization & chemical oxidation.

A Composite waste, when free from toxic substances may be treated as efficiently as domestic sewage, as most of the textile mill wastes contain sufficient nutrients like nitrogen & phosphorous. Trickling filters, activated sludge process & stabilization ponds have been effective in treating textile mill wastes. Extended aeration is found to be very effective in treating strong wastes even without equalization & pretreatment.

### 5.3 Tanning Industry

The tanning industry is one of the old industries in India. Usually the tannery wastes are characterized by strong color high BOD, high pH & high dissolved salts. The concentrated growth of this industry in certain localities has shown how the waste from this industry can issue severe damage to the water environment in the vicinity. In view of this peculiar pollution potential and the increasing demand for good quality water, it has become essential to treated it waste to a certain degree prior to its disposal.

#### Manufacturing process

Tanning process consists of 3 basic stages

1. Preparation of hides for tanning
2. Tanning proper
3. Finishing

### **Preparation of hides for tanning**

In the first stage, the hides are used to remove dirt and preservative salts use earlier, and soaked in fresh water containing sodium chloride and preservative chemicals 1-5 days. The soaked hides are then washed again in sufficient water.

The washes hides are then lined with a paste of lime in sodium sulphide. Lined hides are then mechanically cleaned off hairs & flushing in wooden Vats with running fresh water. The subsequent operations are de liming and bating. Bating prepares the hides for tanning by reducing pH. Reducing the swelling and removing the degradation products in it. The deliming and bating is carried out in vertically ground in warm solution of ammonium salts and commercial prepared enzymes. An additional treatment known as pickling is required for preparing the height for "chrome tanning". Which involve treatment of hides with sodium chloride and acids.

### **Tanning proper**

The second stage of leather making, the tanning, involves the treatment of hides to make them non putrescible and soft even when dried. Depending on the type of product, either r vegetable substances containing natural tanning's such as extract of barks, wood, nuts etc. or inorganic chroming salts are used as tanning agents. The use of synthetic tanning materials is expensive and is not adopted anywhere in India.

Vegetable tanning is used for leather, while chrome tanning is used for light leathers. In Chrome tanning process the tanning is done in the same vat after one day of pickling by adding the solution of chromium sulphate. After 4 hours of tanning, the leather is bleached with the dilute solution of sodium sulphate and sodium carbonate in the same vat. The chromes tanned leather is then pulled out and half of the spent liquor is thrown out and remaining is reused and along with a fresh volume of water. The vegetable tanned leathers are washed after the tanning proper.

### **Finishing**

The third stage of finishing consists of stuffing and fat liquoring followed by dyeing. Dyeing can be done using synthetic stuffs.



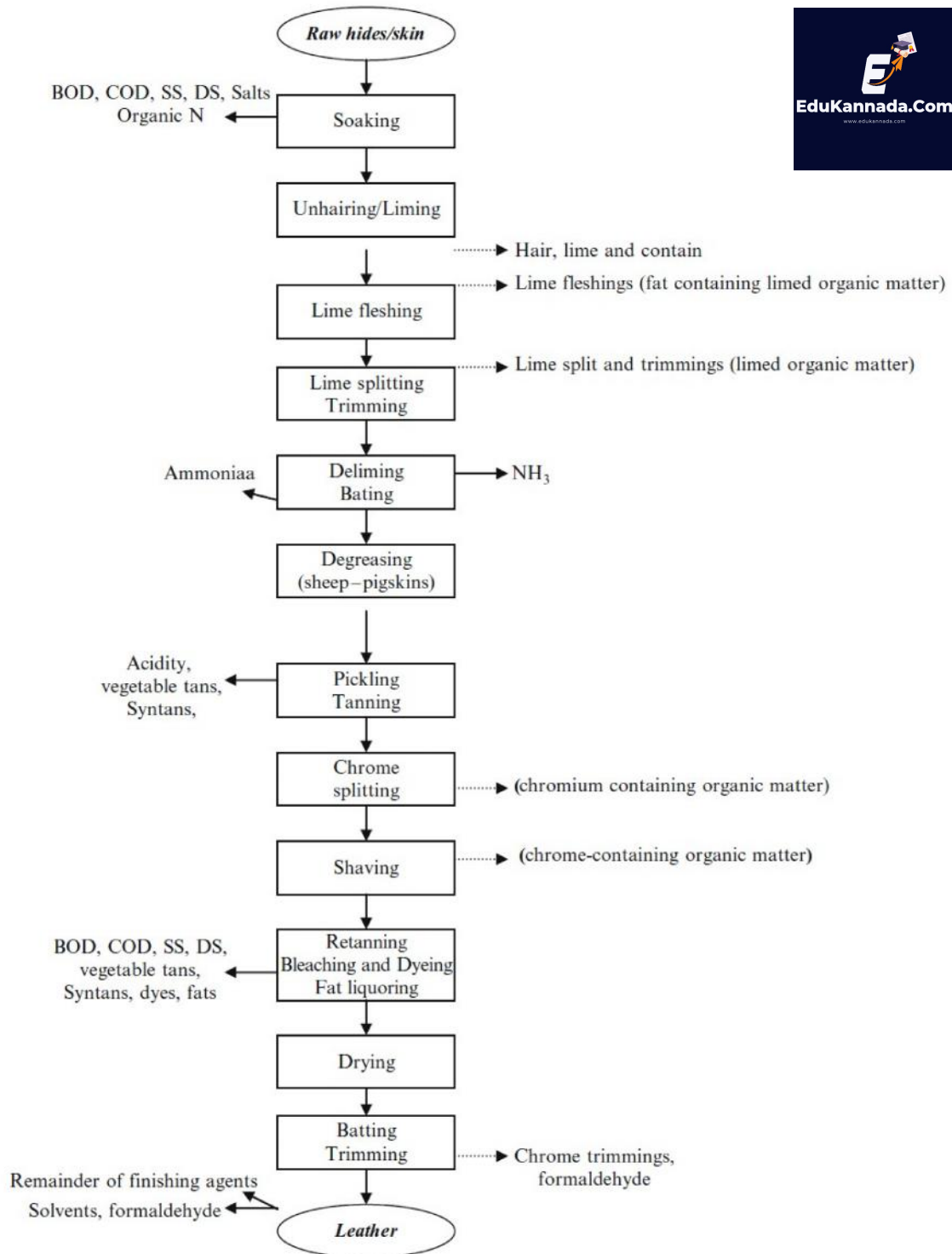

### Sources and characteristics of waste water

The waste water originates from the all operations in the tanning process. The waste may be classified as continues flow water, and intermittent flow waste. Continues flow waste consists of wash water after various processes and comprises of large portions of the total waste and are relatively and less polluted then the other one. Spent liquors belonging to soaking, liming and bating, pickling, tanning and finishing operation are discharged

intermittently. Although small in volume, they are highly polluted and contain varieties of solute and organic and inorganic substances.

The spent and soaked liquor contains soluble proteins of the hides, dirt and large amount of common salt where salted hides are process. This spent liquor under goes putrefaction very rapidly as it offers a good amount nutrient and favorable environment of bacterial growth. The growth of pathogenic – anthrax bacteria in this waste is also reported.

The spent lime liquor contains dissolved and suspended lime, colloidal proteins and their degradation products, sulphides emulsified fatty matters and also carrying a sludge composed of unreacted lime, Calcium sulphide and calcium carbonate. As such the spent lime liquor as a high alkalinity and moderate BOD and high ammonia nitrogen content.

The spent bate liquor contains high amount of organic and ammonium nitrogen due to the presence of soluble skin proteins and ammonia salts used in bating.

The vegetable ton exact containing tannins and also non tannins. Tannins are of high COD but relatively low BOD value. While non tannins including inorganic salts, organic acids and salts and sugar are of high BOD and COD. The spent vegetable tanning liquor is the strongest individual waste in the vegetable tannin having the highest BOD and very strong dirty brown color.

The spent pickling and chrome tanning waste comprises of as small volume, having a low BOD and contains traces of proteins impurities, sodium chloride and minerals acids and chromium salts. Chromium is known to be highly toxic to the living aquatic organisms.

Table shows the characteristic of Indian Tannery Industrial wastewater

Item	Spent soak liquor	Spent lime liquor	Spent delime liquor	Spent bating liquor	Spent vegetable tan liquor	Spent chrome tan liquor	Spent dyeing liquor
pH	8.4	12.8	9.3	9.9	5.4	3.2	6.2
Alkalinity as CaCO <sub>3</sub> , mg/L	600	1600	800	600	-	-	-
Acidity as CaCO <sub>3</sub> , mg/L	-	-	-	-	2560	5400	1000
Chloride, mg/L	16800	8900	400	240	3000	-	1000
Total solids, mg/L	35800	38240	27450	5000	34800	7480	4255
Suspended solids, mg/L	4500	3590	445	1060	2660	705	1255
COD, mg/L	3584	12000	2500	2374	30240	3584	6720
BOD, mg/L	708	7300	775	887	16000	-	-

### Effects of waste on streams and sewage plant

Tannery waste characterized by high BOD, high suspended solids and strong colors. The waste when discharged into streams they deplete the DO very rapidly due to both chemical and biological oxidation of sulphide and organic compounds. A secondary pollution of streams may occur due to the deposition of solids near the discharge points and its subsequent putrefaction. The gas evolved during this process as got a typical foul odor.

Chlorides in excess of tolerance limits (500mg/ L) render the water unsuitable for future use. The chromium is toxic to aquatic life and inhibits the growth of fish in the stream. Even the lagooning of the untreated tanning waste on open land may adversely affect the ground water and near the surface water sources due to seepage of dissolved solids. This makes the soil unsuitable for cultivation for this high salt content.

The tannery waste when discharged into sewer not only chokes the sewer due to the deposition of solids but also reduces the cross section of the sewer arising out of the lime encrustature.

Chromium compounds in excess of 10-20mg disrupt the operation of the trickling filter. Sulphides are also toxic to the micro organisms are removed along with the sludge. The sludge is dried over sand drying beds and can be used as good manure. Chemical coagulation (Alum, ferric chloride, and ferrous sulphate) with or without prior neutralization followed by biological treatment is necessary for better quality of effluent.

### **Treatment of wastewater**

The method of treatment of tannery waste may be classified as physical, chemical and biological. The physical treatment includes mainly screening and primary sedimentation. Screen are required to remove fleshing, hairs and other floating substance. A continuous flow sedimentation tank, designed on maximum hourly flow with 4 hrs of detention, and is found to be effective in 90% removal of suspended solid. About 98% of the chromium is precipitated in the primary sedimentation tank and is removed along with the sludge. The sludge is dried over sand drying beds and can be used as good manure. No appreciable reduction of dissolved solids, BOD, COD, color and chloride can be achieved in the physical treatment processes.

Chemical coagulation with or without neutralization, followed by biological treatment is necessary for better quality of the effluent. Several coagulants like alum, ferric chloride and ferrous sulphate have been tried for chemical coagulations. Chemical coagulation with ferric chloride alone is reported to be quite effective in the removal of tannin and COD.

Biological treatment of the tannery waste, in activated sludge process, after mixing with municipal wastewater in a suitable proportion, and using acclimatized microorganism is capable to reduce the BOD, COD and tannin by about 90%. Trickling filter may also be used for effective removal of BOD, COD and color. The low cost treatment methods may effectively be used for the treatment of tannery wastes. Both oxidation pond and anaerobic lagoons are recommended for small and isolated tanners. Anaerobic lagoons require less land area and nutrient addition compared to those in oxidation ponds.

### **5.4 Cane Sugar and Distillery Industry**

In countries like India, Cuba & Jamaica the sugar is produced from sugar canes, while in many other but roots are used as raw material for the sugar production. In India, most of the sugar mills are situated in the country side & operate for about 4-8 months just after the harvesting of the sugar canes. A large volume of waste of organic nature is produced during the period of production & normally they are discharged on to land or onto the nearby water source usually small streams practically without treatment.

## Manufacturing process

The sugar cane is normally harvested manually in India, which eliminates the carriage of soil & trashes to the factory along with the sugar canes. The sugarcanes are cut into pieces & crushed in a series of rollers to extract the juice in the mill. Then for sugar canes of Lime is then added to the juice & heated where in all the colloidal & suspended impurities are coagulated. Much of the color is also removed during lime treatment. The coagulated juice is then clarified to remove the sludge. The clarifier sludge is further filtered through filter process & then disposed off as solution waste. The filtrate is recycled to the process and the entire quantity of clarified juice is treated by passing sulfur dioxide gas through it. The process is known as sulphitation process. Here color of the juice is completely bleached out due to this process.

The clarified juice is then pre- heated & concentrated in evaporators & vacuum pans. The partially crystallized syrup from the vacuum pan is known as Masecuite is then transferred to the crystallizers, where complete crystallization of sugar occurs. The masecuite is then centrifuged, to separate the sugar crystals from the mother liquor. The spent liquor is discarded as black strap molasses. The sugar is then dried & bagged for transport.

The fibrous residue of the mill house known as bagasses may be burnt in the boilers or may be used as raw materials for the production of paper product. The black strap molasses may be used in the distilleries.

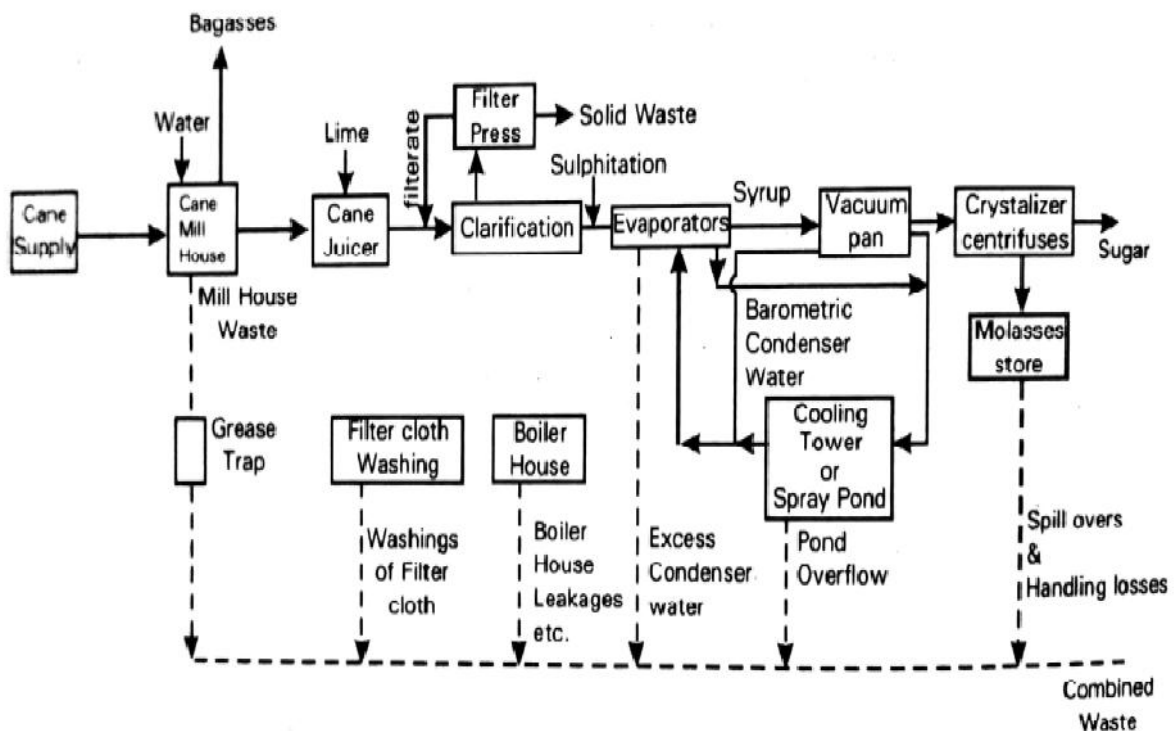

## Sources and characteristics of wastes

Waste from the mill house include the water used as splashes to extract maximum amount of juice & those used to cool the roller bearings. As such the mill house waste contains high BOD due to the presence of sugar & oil from the machineries. The filter cloths



used for filtering the juice needs occasional cleaning. The wash water thus produced through small in volume, contains high BOD & suspended solids.

A large volume of water is required in the Barometric condensers of the evaporators & vacuum pan. The water is usually partially or fully circulated after cooling through a spray pond. This cooling water gets polluted as it picks up some organic substances from the vapour of boiling syrup in evaporation & vacuum pans. This polluted water, instead of recirculated is discarded as excess condenser water. These discharges contribute substantially to the waste volume & modulated to BOD in many sugar mills.

Additional waste originates due to the leakages & spillages of juice, syrup & molasses in different sections. The periodical washings of the floor through small in volume have got very high BOD. The periodic blow off of the boilers produces another intermittence waste discharge. This waste is high in suspended solids, low in BOD & usually alkaline.

Characteristics	Value
pH	4.6-7.1
Total solids	870-3500 mg/l
BOD	300-200 mg/l
COD	600-4380 mg/l
Total suspended solids	220-800 mg/l
Total Nitrogen	10-40 mg/l

### Effects of wastes on receiving water

The fresh effluent from the sugar mill decomposes rapidly after few hours of stagnation. It has been found to cause considerable difficulties when this effluent gets an access to the water course particularly the small & non perennial streams in the rural areas. The rapid depletion of oxygen due to biological oxidation followed by anaerobic stabilization of the waste causes secondary pollution of offensive odor, black color & fish mortality.

### Treatment of the wastewater

Like any other industry the pollution load in sugar mills can also be reduced with a better water and material economy practiced in the plant. Judicious use of water in various plant practices & it recycle, wherever practicable, will reduced by recycling cleaning of floors or floor washings using controlled quantity of water will also reduce the volume of waste to certain extent.

The organic load of the waste can only be reduced by a proper control of the operations. Over loading of the evaporates & the vacuum pans and the extensive boiling of the syrup leads to a loss of sugar through condenser water & this in turn increases both volume & strength of the waste effluent. Disposal of the effluent on land as irrigation water is practiced in many sugar mills, but it is associated with odor problems.

Anaerobic treatment of the effluent using both digesters and lagoons has been found to be very effective & economical. A BOD reduction of both 70-88% was observed in pilot plant study with an anaerobic digester, where BOD loading was 0.65-1.79 kg/m<sup>3</sup>/day with a detention time of 2- 2.4 days at a controlled temperature of 37°C.

The effluents of the anaerobic treatment units are found to contain sufficient nutrients (nitrogen & phosphorous) as such further reduction of BOD can be accomplished in aerobic waste stabilization ponds.

### 5.5 Dairy Industry

With increase in demand for milk & milk products, many dairies of different sizes have come up in different places. These dairies collect the milk from the producers & then either packed it for marketing or produce different milk foods according to their capacity. Large quantity of waste water originates due to their different operations. The organic substances in the wastes comes either in the form in which they were present in milk or in a degraded form due to their processing. As such the dairy wastes though biodegradable are very strong in nature.

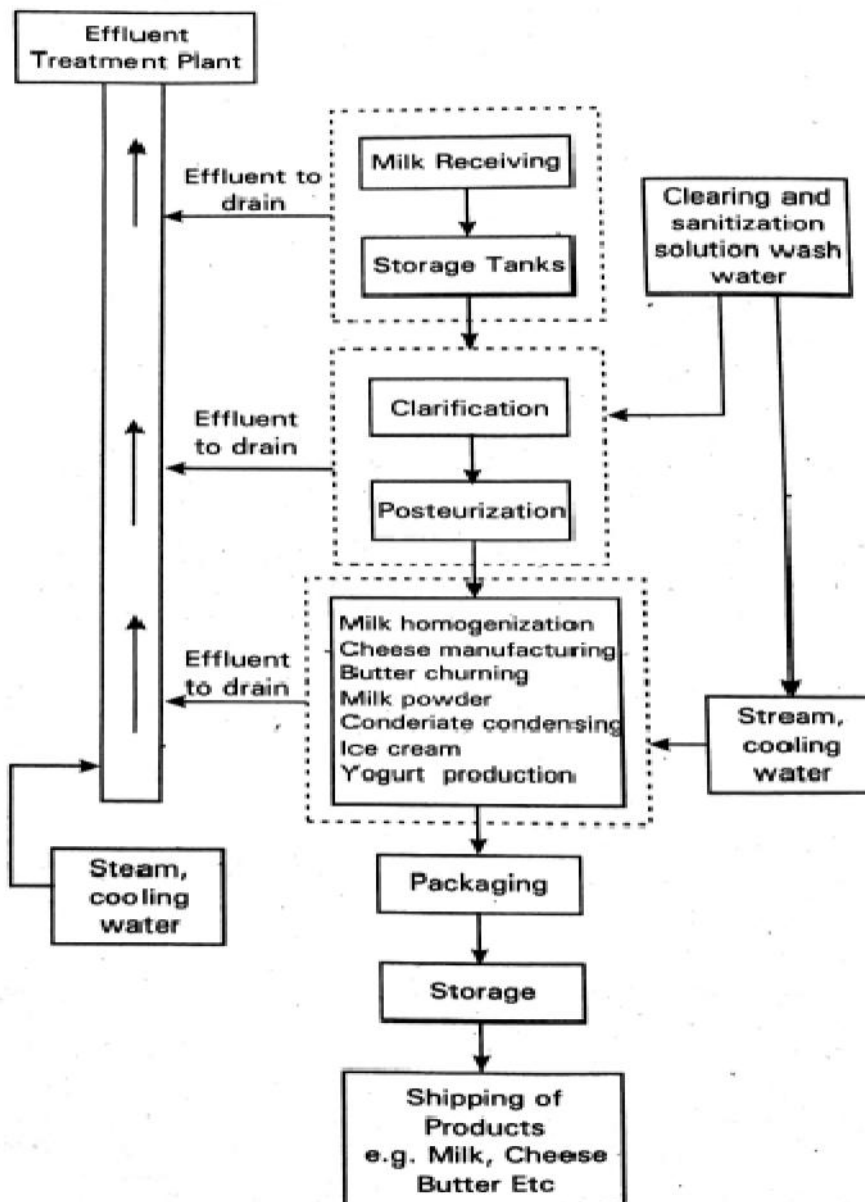

#### Processing and sources of wastes

The liquid waste from a large dairy originates from the following sections or plants. Receiving station bottling plant, cheese plant, butter plant, casein plant, condensing plant, dried milk plant & ice cream plants. Wastes also come from water softening plant & from

bottle and washing plants. At the receiving station, the milk is received from the farmers and is emptied into large containers for transport to bottling of other processing plants. The empty can be rinsed, washed and sterilized before returning to the farmers. At the bottling plants the raw milk delivered by receiving station is stored. The processing includes cooling, filtration, clarification, pasteurization and bottling.

In the above two sections, the liquid wastes originate out of rinse & washings of bottles, cans & equipments & thus contain milk drippings and chemicals used for cleaning containers & equipments.

In a cheese plant, the milk (whole milk or skimmed milk) is pasteurized and cooled and placed in a vat, where a starter (lactic acid producing bacterial culture) and rennet are added. This separates the casein of the milk in the form of curd. The whey is then withdrawn and the curd compressed to allow excess to drain out. Other ingredients are now added and the cheese blocks are cut and packaged for sale. Waste water from this plant includes mainly the discarded whey and wash water used for cleaning vats, equipments floor.

In the creamery process the whole milk is pre heated to about 30<sup>0</sup>C to separate the cream from the milk. In a butter plant, the cream is pasteurized and may be ripened with a selected acid and a bacterial culture. This is then churned at a temperature of about 7- 10<sup>0</sup>C to produce butter granules. At the proper time the butter ilk is drained out of the churned & the butter is washed & after standardization packaged for sale. Butter milk and wash waters used to clean the churns and small quantity of butter comes out as waste from the butter plants.

The skimmed milk may now be sent for bottling for human consumption or for further processing in the dairy for other products like non fat milk powders. Milk powders are produced by evaporation followed by drying by either roller process or spray process. The dried milk plant wastes consist of chiefly of wash waters used to clean containers & equipments.

The scoured or spoiled milk and some time the skimmed milk are processed to produce caseins used for preparation of some plastics. The process involves the coagulation & precipitation of the casein by the addition of some mineral acids. The wastes from this section include whey, washings and the chemicals used for precipitation. Very large dairies also produce condensed milk & ice creams.

In addition to the wastes from all the above milk processing units, some amount of uncontaminated cooling water comes as waste. These are usually recirculated. The dairy wastes are very often discharged intermittently. The nature & composition of the waste also depends on the types of products produce & the size of the plants.

### **Effects of the waste on the receiving water and sewage plants**

As the dairies are usually situated in rural areas or in small towns, the question of discharging the dairy waste in to the sewers does not arise.

The waste is basically organic in nature. This is also slightly alkaline when fresh. When these wastes are allowed to go into the stream without any treatment, a rapid depletion of DO of the stream occurs along with growth of sewage fungi covering the entire bottom of the stream. The waste is said to carry occasionally, the bacteria responsible for tuberculosis (TB). Though alkaline in fresh condition the milk waste becomes acidic due to the decomposition of lactose into lactic acid under anaerobic condition.

The resulting condition precipitates casein from the waste, which decomposes further into a highly odors black sludge. At certain dilution the dairy waste is found to be toxic to fishes also.

### **Treatment of the dairy waste**

Due to low COD, BOD ratio the dairy wastes can be treated efficiently by biological processes. Moreover, these wastes contain sufficient nutrients for bacterial growth. But for economical reasons, attempt should be made to reduce the volume & strength of the waste. This can be accomplished by

1. Prevention of spills, leakages & dropping of milk from the cans.
2. By reducing the amount of water for washes.
3. By segregating the uncontaminated cooling water and recycling the same.
4. By utilizing the buttermilk and whey for the production of dairy bi products of good market value.

Due to the intermittent nature of the waste, it is desirable to provide equalization tank, with or without aeration, before the same is sent for biological treatment. A provision of grease trap is also necessary as a pretreatment to remove fat & other greasy substances from the wastes. Aeration for a day not only prevents the formation of lactic acid, but also reduces the BOD by about 50%.

Both high rates trickling filters & activated sludge plants can be employed very effectively for a complete treatment of the dairy waste. But these convention methods involve much maintenance, skilled methods like oxidation ditch, aerated lagoon, waste stabilization pond etc., can be employed with simpler type of equipments & less maintenance.

Use of the dairy waste for irrigation after primary treatment in an aerated lagoon may be a good answer for the disposal of dairy wastes.

### **5.5.1 Distillery Industry**

Production of ethyl alcohol in distilleries based on cane sugar molasses constitutes a major industry in Asia and South Africa. The world's total production of alcohol from cane molasses is more than 13 million<sup>3</sup>/annum. The aqueous distillery effluent stream known as spent wash is a dark brown highly organic effluent and is approximately 12-15 times by volume of the product alcohol. It is one of the most complex, troublesome and strongest organic industrial effluents having extremely high COD and BOD values.

#### **Manufacturing process**

In India bulk of the alcohol is being produced from sugar cane molasses. Molasses is a thick viscous byproduct of the sugar industry which is acidic in nature, rich in salts, dark brown in color and it also contains sugar which could not be crystallized. For manufacturing alcohol, the molasses is diluted with water into a solution containing 15-16% of sugars. This solution is then inoculated with yeast strain and is allowed to ferment at room temperature. The fermented liquor containing alcohol is then sent to an over head tank without separation of the solid materials. The same is then degasified and the alcohol is stripped leaving a spent wash. The crude alcohol is then redistilled and stored in bags. Some of the alcohols like gin attain their final form at this stage; some other like whisky requires ageing is charred oak

wood barrels. For manufacture of alcoholic beverages, the alcohol is, if required, matured and blended with malt alcohol and diluted to requisite strength to obtain the desired type of liquor/Indian Made Foreign Liquor (IMFL). This is bottled in bottles of various sizes for the convenience of consumers.

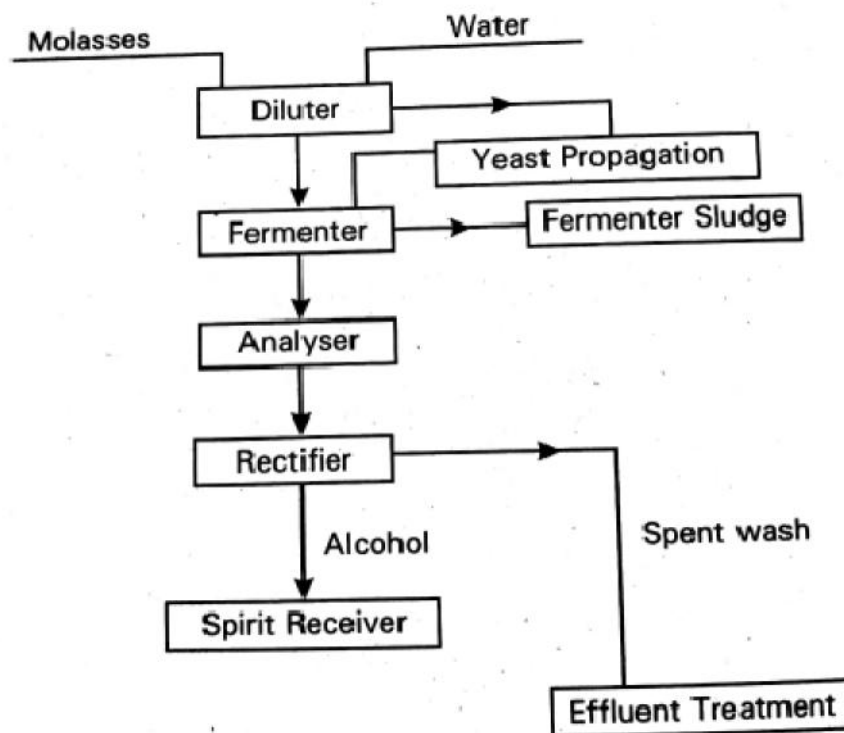

### Origin and characteristics of distillery wastes

The spent wash is the major polluting component of the distilleries and it is reported to be 10-15 times the final product in volume. The other pollutants include yeast sludge, which deposits at the bottom of fermentation vats. In most of the distilleries in India this yeast sludge is mixed with the spent wash and discharged. In addition to these, major BOD and solids contributing wastes, floor washes waste cooling water and wastes from the operations of yeast recovery or by products recovery processes also contribute the volume of these waste.

### Effects on receiving streams/ sewers

All the above types of wastes discussed earlier are not toxic to the aquatic life of the receiving stream. But due to their high BOD content, they depict the DO of the receiving water. This results in anaerobic decomposition of this organic solids, both settled & suspended, producing a malodorous condition over the fairly long stretch of the stream. The conditions further deteriorate due to the growth of sewage fungi. The dark color of the stream renders it unaesthetic.

Brewery waste, which is comparatively of lesser strength, may be discharged in a fresh condition into the sewers to the extent of 3-5 % of the domestic sewage. The strong acidic or putrefied brewery waste will disrupt the normal biological activities of the waste treatment

plants. For the sake of safe the brewery waste, if discharged into the sewers must be screened & pre treated by lime. The very high BOD content of the distilled waste makes it non amenable to the aerobic biological treatment and as such it cannot be discharged into municipal sewerage system directly.

Brewery wastes being comparatively less strong can be treated by aerobic biological treatment, after screening and neutralization. Usually, the biological treatment is accomplished by two stage process for 90-94% BOD reduction. A flow sheet of one such brewery waste treatment plant employing high rate trickling filters is shown in fig. When sufficient land is available, the brewery waste may be used for broad irrigation after neutralization to utilize the fertilizing components of the waste.

## **5.6 Steel Industry**

Integrated steel plants usually consist of five main units such as coal washery, coke oven, blast furnace, steel melting shop and rolling mills

### **Coal washery and its wastewater**

The coal needs some processing to make it suitable for use in coke ovens. The main objective of such treatment is the removal of solid foreign matter present in the coal. Generally the processes in a coal washery include crushing, screening and wet washing of coal. In the wet process the coal is separated from the impurities using the principle of differential settling. Water used for washing is recycled and re-used after sedimentation. But in spite of all care taken to ensure maximum reuse, appreciable quantity of wash water containing coal fines and other impurities like shale, clay and small amounts of other minerals like calcite, gypsum, kaolin, pyrite etc, comes out as waste.

### **Coke ovens and their wastewater**

The production of coke involves the carbonization of bituminous coal by heating in the absence of air at a temperature range of 900-1100<sup>o</sup>C in an oven, which drives off all volatile portions in the coal. The gas which is evolved containing the volatile matters is collected through the stand pipes and is cooled in stages. In the first stage the gas is cooled to about 80<sup>o</sup>C by spraying cold liquor over the gas, thereby producing mainly tar as the condensate. In the second stage by a further cooling to about 30<sup>o</sup>C, condensate containing additional tar and ammonia liquor is produced. These two condensate liquors after the separation of tar in a tar-decantor, are recycled as sprays in the first stage. The excess liquor known as ammonia liquor, containing mainly ammonia and various other compounds is subjected to distillation for the recovery of ammonia, the waste is sent for further treatment. After the second stage of cooling, i.e., in the third stage, the gas is compressed and cooled for further recovery of chemicals

The coal after being carbonized is removed from the oven and quenched by cold water. About 30% of the quenching water is evaporated while the remaining water containing coke fines comes out as waste. This wastewater is usually recirculated through settling ponds and does not present any pollution problem.

**Blast furnace and its wastewater**

Blast furnace is a basic unit in an integrated steel plant. Essentially the blast furnace process consists of charging iron ore & coke as fuel, limestone & dolomite as fluxing material into the top of the furnace & blowing heated air into the bottom. Pig iron is the metallic product of this unit. Appreciable quantity of water is used in blast furnace for the purpose of cooling & gas cleaning operations. However, the cooling water normally remains uncontaminated & is reused after cooling. The entire quantum of wastewater originates from the gas cleaning operations.

**Steel melting and its waste**

In the steel melting, the pig iron obtained from the blast furnace is further treated to produce ingots. The basic principle involved is the oxidation of unwanted impurities in the pig iron which lead to the production of steel ingots. Water requirement in the steel melting processes lies in keeping the furnace body cool. And as such this water remains uncontaminated & is reused

**Rolling mills & their waste**

The steel ingots obtained from the steel melting are rolled to different products in the rolling mills. However, the ingots are heated first in the soaking pits until these are plastic enough for economic reduction by rolling. Ingots are usually rolled into blooms, billets or slabs depending upon the final product. These rolled blooms, billets and slabs are then cooled & stored & subsequently sent to another mill, where these are re-rolled to produce finer products.

During the process of rolling of ingots, blooms, billets and slabs, lots of scales are given off and are collected in the scale flume, below the roll tables. These scales are flushed down with high pressure water and are collected at the scale pit. The rolls also get heated up during the process, and cool with liberal supply of water. This water also joins the waste water flow through flume. Naturally it carries a lot of oil and grease.

**Effects of the steel plants waste on receiving water**

Pollutants that of main concern in integrated steel plant waste are suspended solids, cyanides, acids, ammonium compounds, phosphates, phenols, oils etc. If the spent ammonical liquor is discharged into a stream without any treatment, the phenol alone can disturb the ecology of the receiving stream. It carries several elements which are toxic to aquatic life; among them some are objectionable to human consumption.

When phenol bearing water is chlorinated, chlorophenols will be formed. These chlorophenols are detected by taste in drinking water even at a concentration of 0.005mg/L. The black suspended solids of an untreated waste discharge pollute the bed & the banks of the stream with a thick deposit. The reason for eutrophication in stream is generally attributed to the presence of excess amount of phosphates in the effluent.

**Treatment of wastewater Conventional Method**

- Primary treatment consists of temporarily holding the sewage in a quiescent basin where heavy solids can settle to the bottom while oil, grease and lighter solids float to

the surface. The settled and floating materials are removed and the remaining liquid may be discharged.

- Secondary treatment removes dissolved and suspended biological matter. Secondary treatment is typically performed by indigenous, water-borne micro-organisms in a managed habitat. Secondary treatment may require a separation process to remove the micro-organisms from the treated water prior to discharge or tertiary treatment.
- Tertiary treatment is sometimes defined as anything more than primary and secondary treatment. Treated water is sometimes disinfected chemically or physically (for example, by lagoons and microfiltration) prior to discharge into a stream, river, bay, lagoon or wetland, or it can be used for the irrigation of a golf course, green way or park. If it is sufficiently clean, it can also be used for groundwater recharge or agricultural purposes.

### 5.6.1 Cement Industry

Cement industry contributes much to air pollution & liquid effluents are not problem Raw materials

It is a compound made up of calcium oxide & silicon di oxide along with aluminium oxide, ferric oxide & magnesium oxide. Raw materials required for the manufacture of cement are lime, sand clay, shale, iron –ore & blast furnace slag.

#### Cement Manufacturing Process Phases

Production of cement completes after passing of raw materials from the following six phases. These are;

1. Raw material extraction/Quarry
2. Grinding, Proportioning and Blending
3. Pre-heater Phase
4. Kiln Phase
5. Cooling and Final Grinding
6. Packing & Shipping

#### Cement Manufacturing Process Phase 1: Raw Material Extraction

Cement uses raw materials that cover calcium, silicon, iron and aluminum. Such raw materials are limestone, clay and sand. Limestone is for calcium. It is combined with much smaller proportions of sand and clay. Sand & clay fulfill the need of silicon, iron and aluminum generally cement plants are fixed where the quarry of limestone is nearby. This saves the extra fuel cost and makes cement somehow economical. Raw materials are extracted from the quarry and by means of conveyor belt material is transported to the cement plant.

There are also various other raw materials used for cement manufacturing. For example shale, fly ash, mill scale and bauxite. These raw materials are directly brought from other sources because of small requirements.

Before transportation of raw materials to the cement plant, large size rocks are crushed into



smaller size rocks with the help of crusher at quarry. Crusher reduces the size of large rocks to the size of gravels.

### **Cement Manufacturing Process Phase II: Proportioning, Blending & Grinding**

The raw materials from quarry are now routed in plant laboratory where, they are analyzed and proper proportioning of limestone and clay are making possible before the beginning of grinding. Generally, limestone is 80% and remaining 20% is the clay.

Now cement plant grind the raw mix with the help of heavy wheel type rollers and rotating table. Rotating table rotates continuously under the roller and brought the raw mix in contact with the roller. Roller crushes the material to a fine powder and finishes the job. Raw mix is stored in a pre-homogenization pile after grinding raw mix to fine powder.

### **Cement Manufacturing Process Phase III: Pre-heating Raw Material**

After final grinding, the material is ready to face the pre-heating chamber. Pre-heater chamber consists of series of vertical cyclone from where the raw material passes before facing the kiln. Pre-heating chamber utilizes the emitting hot gases from kiln. Pre-heating of the material saves the energy and make plant environmental friendly.

### **Cement Manufacturing Process Phase IV: Kiln Phase**

Kiln is a huge rotating furnace also called as the heart of cement making process. Here, raw material is heated up to 1450 °C. This temperature begins a chemical reaction so called decarbonation. In this reaction material (like limestone) releases the carbon dioxide. High temperature of kiln makes slurry of the material.

The series of chemical reactions between calcium and silicon dioxide compounds form the primary constituents of cement i.e., calcium silicate. Kiln is heating up from the exit side by the use of natural gas and coal. When material reaches the lower part of the kiln, it forms the shape of clinker.

### **Cement Manufacturing Process Phase V: Cooling and Final Grinding**

After passing out from the kiln, clinkers are cooled by mean of forced air. Clinker released the absorb heat and cool down to lower temperature. Released heat by clinker is reused by recirculating it back to the kiln. This too saves energy.

Final process of 5th phase is the final grinding. There is a horizontal filled with steel balls. Clinker reach in this rotating drum after cooling. Here, steel balls tumble and crush the clinker into a very fine powder. This fine powder is considered as cement. During grinding gypsum is also added to the mix in small percentage that controls the setting of cement.

### **Cement Manufacturing Process Phase VI: Packing and Shipping**

Material is directly conveyed to the silos (silos are the large storage tanks of cement) from the grinding mills. Further, it is packed to about 20-40 kg bags. Only a small percent of cement is packed in the bags only for those customers whom need is very small. The remaining cement is shipped in bulk quantities by mean of trucks, rails or ships.

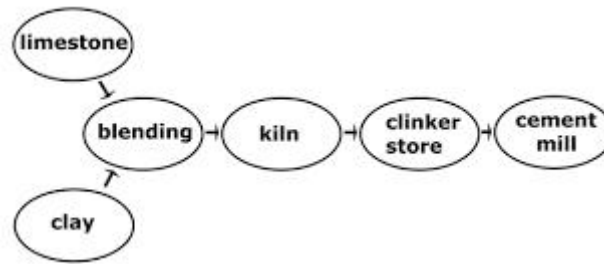

### Sources of effluent

Cooling water- It can be recycled after cooling as it does not contain harmful materials

Wet scrubbing effluent – Wet scrubbing of kiln dust yields an effluent that has a high pH value, alkalinity, suspended & dissolved solids like sulfate & potassium predominates.

### Wastewater and Industrial Process Wastewater Treatment

In cement industries water is used only for cooling operation of manufacturing process. Process wastewater with high pH and suspended solids may be generated in some operations. Generally water used for cooling purpose is recycled and reused in the process. Screening and for suspended solid reduction is done by using settling basin and clarifier. Water treated from waste water treatment plant should use for green belt development. This green belt also helps in minimizing noise pollution.

At lime mining site and cement plant contaminated streams of rain water should be directed to the waste water treatment plant and should use for industrial process. Storm-water flowing through pet-coke, coal, and waste material stockpiles exposed to the open air may become contaminated. Rain water should be protected from contacting from coal depot clinker and lime and fly ash storage area to prevent contamination by covering the storage area and should collect at some tank for further use in dust suppression system at plant. If storm-water does contact storage yard than it may indicate presence of high value of sulphate in soil and toxic metals like Zinc, Lead and Chromium in the dust and high TDS value in ground water.

### 5.7 Paper and Pulp Industry

The paper mills use the Pulp as the raw materials which is again produced utilizing different cellulosic materials like wood, bamboo etc., in the pulp mills. The pulp & paper mill wastes characteristically contain very high COD & color. The presence of lignin in the waste, which is not easily biodegradable, makes the COD/BOD ratio of the waste very high. It may be noted that, the pollution potential of the paper mills are negligible compare to that of the pulp mills. As such, it is the pulp making process which is responsible for the pollution problem associated with the integrated pulp & paper mills.

### Manufacturing process & the sources of the waste

The volume & characteristics of the waste depends on the type & manufacturing process adopted & the extent of reuse of water employed in the plant. The process of manufacturing of paper & pulp making & then making the final product of paper.

In the pulp making phase, the chipped cellulose raw materials are digested with different chemicals in one tank under high temperature & pressure. The process thus loosens the cellulose fibers & dissolves the lignin & resin & other non cellulosic materials in the raw material. The kraft process or sulphate process of pulp making uses sodium, sulphate, sodium

hydroxide & sodium sulphide as the above mentioned digestive chemicals. Another process of pulp making known as sulphide process uses magnesium or calcium bisulphate & sulphurous acid as the digestive chemicals. The alkali process uses sodium hydroxide or lime for pulp making.

The spent liquor produced by the above process of digestion is known as “Black Liquor”. This is not only very rich in lignin content, but also contains a large amount of utilized chemicals. Therefore this black liquor is treated separately for the recovery. So while the entire quantity of the liquor is up hide process makes the colored waste from the section, in the kraft process, the same is produced due to the leakages, spillages or overflow only from the digester. The cellulosic fiber after being separated from the black liquor is washed & then partially dewatered.

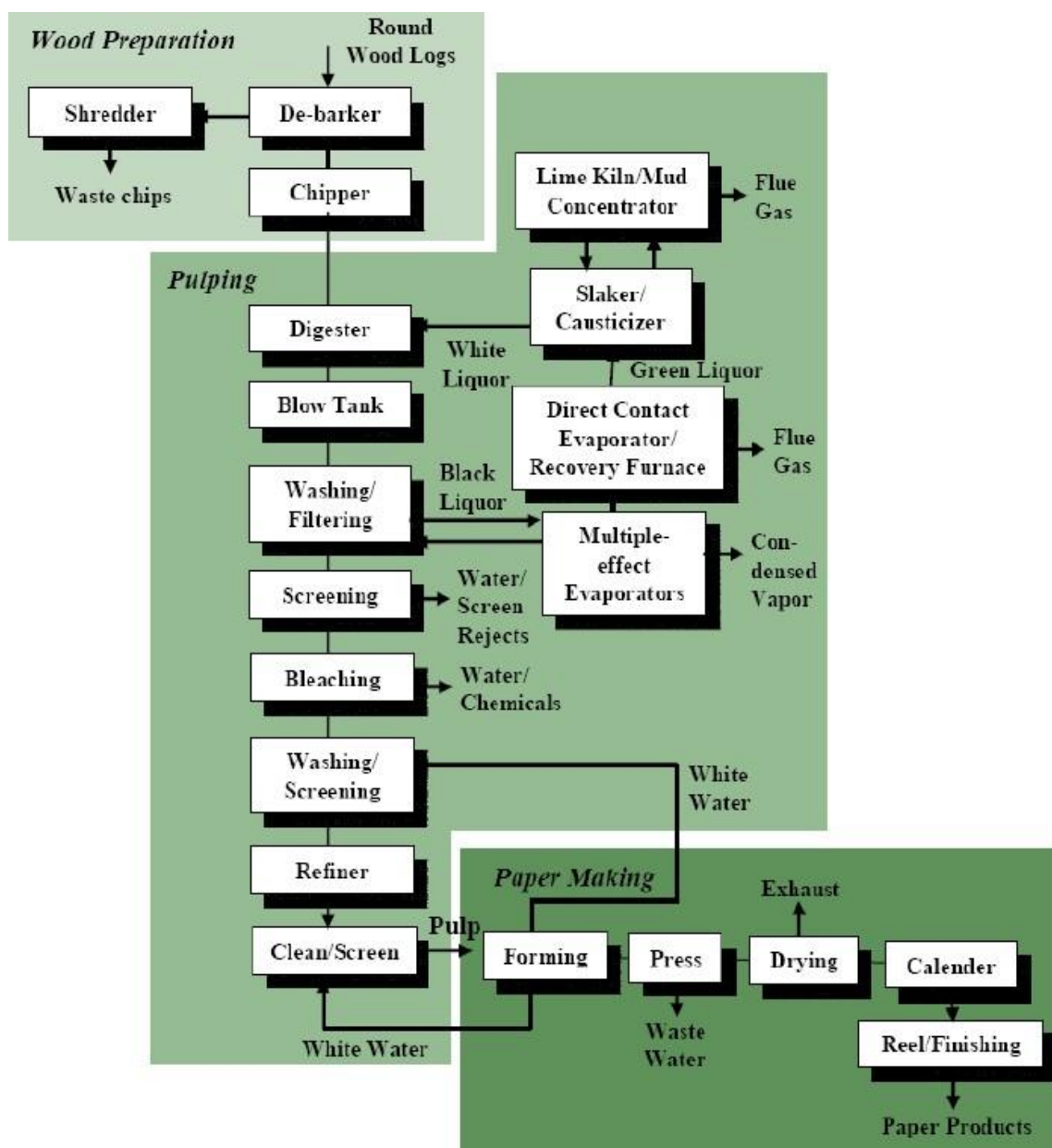

A concentrated wash water may be sent for chemical recovery) in the kraft process. The dilute wash water from the waste water. This volume of waste water is known as “Brown

stock wash” or “Unbleached Decter waste”.

The washed cellulosic fibers are then sent for the bleaching in 3 stages, where chlorine, caustic & hypochloride are used in successive stages. Waste waters from the first & the last stages are light yellow in color while that from the caustic extraction stage is highly colored. The bleached pulp is then sent for the paper mill. In the paper mill, the pulp is disintegrated & mixed with various filter materials like alum talc, etc and dyes on an along shaped especially pulp is refined in a machine known as “jorda”. The refined pulp is then diluted to proper consistency for paper making and passed through a screen to remove lumps or knots. Now this pulp is carried by a travelling belt of fine screen to a series of rolls, where the final product, the “paper” is produced. The drained water often called as “White water” forms the waste water from the paper mill section. This waste water contains fine fibers, alum, talc, etc. Usually the fibers are recovered from this waste; the treated liquid is reused for the wet chipping process.

The black liquor of the kraft process concentrated by evaporation and then incineration with the addition of sodium sulphate . The organic like lignin, resin etc are burnt off & the smell is dissolved in water .the resulting liquid is known as “green liquor” lime is now added to this liquor resulting in the formation of “ white liquor” & “ lime mud” containing chiefly digesting chemicals & is sent for using digester . The lime mud is calcined (by burning) to form calcium oxide, which is reused to recaustised other green liquors in to the white liquors. Beside those mentioned about, the small volume of waste water is also produced when the bark is removed from the raw wood & the latter is reduced to chips by wet process. Some very toxic waste materials are also generated during the process of chemical recovery from black liquor. Toxic materials like Dimethyl sulphide, methyl mercaptanetc also comes out with digester gases & forms colorless waste water after condensation.

### **Characteristics of pulp and paper mill wastes**

The chemical composition of the wastes depends on the size of the plant, manufacturing process and to a great extent on the material economy practiced (by way of recovery of chemicals and fibers) in the plant. In most of the small paper mills in India, the chemical recovery is not practiced due to economical reasons. As such, the pollution potential of the waste of smaller mills is higher than that of the larger mills. Generally, the pulp and paper mills wastes are characterized by very strong color, high BOD, high suspended solids, and a high COD/BOD ratio.

It may be noticed that too much difference is percent suspended solids contribution from different sections b/w the large and small mills arises due to following reasons.

Large mills produces large amount of lime mud and without being calcined, it is discharged as a waste. This lime mud in the large mills contributes 86.5% of the total suspended solids in the effluent. As such, the percent suspended solids from the digester section; bleaching paper mill section etc. assumes a very low value. On the other hand, no question of lime mud rises in small mill, as it does not have the chemical recovery plant. The waste volume percentage from the digester section is also higher in the case of small mill as the entire quantity of black liquor is wasted in such mills.

**Effects of wastes on receiving water courses or sewers**

Crudes pulp and paper mill wastes or insufficiently treated wastes cause very serious pollution problems, when discharged into the streams. The pollution extends over a very long stretch, due to the presence of slowly decomposing components in the waste. The fine fibers often close the water intake screens in the downstream side.

A toxic effect may also be induced upon the flora and funa of the stream due to sulphites and phenols in the waste.

The bottom deposits of ligniono cellulosic material near the point of discharge of the waste in a stream undergoes slow deposition and may lead to the DO depletion followed by the creation of anaerobic condition and destruction of aquatic life.

The question of discharge of this waste into municipal sewer does not arise due to the large amount and strange nature of the waste.

**Treatment of pulp and paper mill wastes Recovery**

The recovery of the process chemicals and fibers reduces the pollution load to a great extent, where the economy permits; the color bearing "black liquor" is treated for the chemical recovery. The process of recovery is described earlier. However in this process the lignin is destroyed. The same may also be recovered from the black liquor, by precipitation by acidulation with either CO<sub>2</sub> or sulphuric acid. These recovered lignins have got various uses in other industries. The alkaline lignins of kraft process may be used as a dispersing agent in various suspensions. Lignins may be used as raw materials for various other substances like dimethyl sulphoxide, which is used as spinning solvent for polyacrylonitrile fibers. Activated carbons may also be manufactured from the lignins, recovered from the black liquors. The fibers in the white water, from the paper mills are recovered either by sedimentation or by flotation using forced air in the tank.

**Chemical treatment for the color removal**

The chemical coagulation for the removal of color is found to be uneconomical. Attempts have been made to remove color from the waste using the lime sludge. The results are not encouraging. Massive lime treatment process developed in USA is said to be capable of removing 90% of color & 40- 60% of BOD from the waste. In this process, entire quantity of lime normally required for the recaustisation of green liquor into white liquor, is taken & allowed to react first with the colored waste effluent. The color is absorbed by the lime and sludge after setting is used in recausting the green liquor. The treatment of the green liquor with colored lime sludge results in the formation of dark brown liquor containing both desired cooking (digesting) chemicals and color producing component like lignin. This lignin bearing liquor is used as digester liquor and then destroyed along with the fresh lignins, in the subsequent operation of concentration and incineration in the process of chemical recovery.

**Activated carbon for color removal**

- a. Physical treatment for clarification: Mechanically cleaned circular clarifiers along are found to be capable of 70- 80% of the suspended solids from the combined mill effluent. About 95% - 99% removal of settle able solids can be accomplished in the clarifiers. However the BOD reduction is comparatively small and of the order of 25-

- 40% only.
- b. Biological treatment of the waste: Considerable reduction of BOD from the waste can be accomplished in both conventional and low cost biological treatment processes. Some are also effective in the reduction of color from the waste. If sufficient area is available, the waste stabilization ponds offer the cheapest means for treatment. Depth of these ponds vary from 0.9m- 1.5m, the detention period may vary from 12- 30 days. A minimum of 85% removal of BOD is found to be achievable.
  - c. Lagooning: In small mills where the black liquor is not treated separately for the chemical recovery, the strong black liquor must be segregated from the other wastes and stored in a lagoon. The content of the lagoon may be discharged into the stream under favorable conditions in the monsoon.

### 5.8 Pharmaceutical industry

Pharmaceutical industry produces varied type of products. They range from vitamins, synthetic drugs to antibiotics. The raw materials used are includes both organic and inorganic compounds. Some of the pharmaceutical plants do not generate any liquid effluents, while some others discharge little quantities of strong waste & others let out larger volumes.

Due to these wide variations a generalization cannot be drawn on the effluents of pharmaceutical industry. Most of the antibiotics such as penicillin, Streptomycin, lysine, sulfaquinazoline, nicarbazine & vitamins such as B1, B2, B12 and many steroids are prepared in the fermentation. The most waste produced in the fermentation process is the spent beer liquor. The spent beer liquor is the fermented broth remaining after the recovery of antibiotics and other valuables. It contains large amounts of organic materials, proteins and other nutrients and consequently the BOD of these effluents is abnormally high

Five main pharmaceutical wastes and their characteristics are as follows

1. Strong fermentation beers (small in volume but having 4000 to 8000 mg/LBOD)
2. Inorganic solids (waste slurry with little BOD)
3. Washings of floor and equipment ( large percentage of total volume and BOD from 600 to 2500ppm)
4. Chemical waste – solution or solvents which exert a substantial BOD when diluted with other wastes
5. Barometric condenser wastewater – resulting from solids and volatile gases being mixed with condenser wastewater causing 60 to 120 ppm BOD

The antibiotic wastes impart objectionable odors to stream and inhibit biological population and action. If they are discharged into sewer, they must be properly diluted; otherwise they affect the sewage treatment.

The volume and composition vary from unit to unit. Approximately 1000 to 3000 liters of waste will be discharged per 100 kg of products manufactured. No specific conclusion on the characteristics of the effluents can be drawn. In general, they are either highly acidic or highly alkaline and possess a high BOD and COD. Some of the effluents contain toxic substances like cyanides.

If the wastes are discharged into stream, they deplete the dissolved oxygen immediately.

These are corrosive due to their high acidity/alkalinity. Further, some of the substances present in them are toxic to aquatic life.

### **Effects of the waste on receiving water sewer**

If a crude waste from an antibiotic waste is discharged into a stream, it not only imparts an objectionable odour to the stream but also adversely affects the biological process in it. This waste should not be allowed to discharge into a municipal sewer unless the sewage treatment plant is properly designed to handle a widely varying and concentrated waste from such a plant.

### **Treatment of wastewater Antibiotic wastes**

Equalization, neutralization and clarification are the essential steps involved in the primary treatment of these waste. Anaerobic digestion and controlled aeration are proved to be the effective secondary treatments. Activated sludge and oxidation ditch are also employed in some pharmaceutical manufacturing units. The effluent from secondary treatments may be passed on to sand filters to produce effluent of better quality

Sometimes, the antibiotics wastes are evaporated and incinerated. Residues from penicillin and other antibiotics are dried and used in stock food. It is reported that a vacuum dried mycelium from the manufacture of penicillin can be digested to produce methane while reducing the organic matter content by about 55%.

### **Synthetic drug wastes**

The type of treatment largely depends on the products manufactured. Due to the varied characteristics of wastes from different sections of the plant, a careful pilot plant study is essential. Segregation of different waste streams is a preliminary step in the treatment. Acidic wastes are neutralized with lime. Odor producing wastes are chlorinated. Cyanide bearing effluents are subjected to alkaline chlorination. Secondary treatments include biological oxidation with acclimatized microorganisms.

### **5.8.1 Food Processing Industry (Breweries, wineries waste)**

The food manufacturing wastewater contains high concentrations of several organic compounds including carbohydrates, starches, proteins, vitamins, pectines and sugars which are accountable for high COD and suspended solids.

Compared to other industries sectors, the food industry uses much greater volume of water for each ton of product. Wastewater generated from food manufacture has distinct characteristics that distinguish it from common municipal wastewater as it is biodegradable and nontoxic. Food wastewater is widely known for its high concentration of BOD and suspended solid. The constituent of food and wastewater are often complex to predict due to differences in BOD and pH in effluents from vegetable, fruit, milk and meat products and due to the seasonal nature of food processing and post harvesting.

In food processing plants, water use starts with conditioning raw materials such as soaking, leaning, blanching and chilling. It continues with cooling, sanitizing, steam generation for sterilization, power and process heating and finally direct in process use. The water

classification categories used in the food and beverage industry are general purpose, process, cooling and boiler feed.

While breweries and wineries produced beer and wine respectively as large number of products are obtained in distilleries. The range of products from distilleries includes industrial alcohols, rectified spirit absolute alcohol, Silent spirit, beverage alcohol etc. But two things are common in all the products mentioned above.

1. All the above products are obtained through the biochemical process of fermentation by yeast using carbohydrates as raw materials and
2. All the products contain ethyl alcohol in different proportions

In all the industries mentioned above are all characteristically of high BOD and they present a threat to the environment when discharge in to the water sources or to the land without treatment. Due to their varying potential pollution all the three industries will be discussed separately.

### **Manufacture of Beer**

Making of beer essentially consists of two stages

1. Preparation of malt from grains like barley.
2. Brewing the barley.

In the malt making the barley grain are steeped (soaked) to bleach out color and then made to sprout under aerobic conditions. The grain malt is then dried and stored after screening the sprouts out.

The malt from the malt house is then transported to the brewing section, where the wort, the medium for fermentation is prepared by mixing the coarse grain malt with hot water and by transforming the starch to sugars boiling in hops. The wort is then inoculated with a prepared suspension of yeast which common the sugar to alcohol. When the fermentation is complete, the yeast and mall residue is filtered out and finally the beer is carbonated before packing for sale.

As the flavor of the product is of prime importance selection of raw materials & control of process is done accordingly.

### **Origin and characteristics of Breweries wastes**

Brewery wastes originate during preparation of the malt as well as brewing the barley. The spent water from the steeping process of the mall house is one source. This waste includes the water soluble substances of the grain that are diffused into it. Characteristically it contains a large amount of organic soluble solids indicated by a high BOD in the order of 400-800mg/lit and low suspended solids concentration. In the brewing plant, the major pollutant is the fermentation residue or the spent grains. This contains high suspended solids and also a high BOD. Wastes also originate in the preparation of yeast suspension (i.e Pre fermentation section) from washing of containers, equipments& floors and in the process of by product recovery from the spent grains. Large volume of almost unpolluted water also comes up as waste cooling water. While the molt house waste is usually alkaline in nature, the brewing plant is generally acidic.

### **Manufacture, origin and characteristics of wineries wastes**



The wineries utilize the fruit juices as the raw materials. So the first operation in any winery is the pressing of fermentable juice from the fruits like grape. The waste from this operation resembles that from the canning industry and includes the spent fruits or Pomace, wastage of fermentable juice and floor wash wastes etc. The second stage in any winery consists of fermentation of this juice employing the method describes earlier. The wine attains its final form at this stage and requires only blending and bottling for sale. The waste from this stage comes from fermenting, spillages, floor washing etc & resembles that from a brewery. In the third stage i.e the brandy plant, wine of either type or the fermentation residue in the wine making is distilled to obtain brandy. Depending upon the source of the brandy, the waste may have low to very high solid concentration and resembles distillery waste very much.

### **Effects on receiving streams/ sewers**

All the above types of wastes discussed earlier are not toxic to the aquatic life of the receiving stream. But due to their high BOD content, they depict the DO of the receiving water. These results in anaerobic decomposition of this organic solid, both settled & suspended, producing a malodorous condition over the fairly long stretch of the stream. The conditions further deteriorate due to the growth of sewage fungi. The dark color of the stream renders it unaesthetic.

Brewery waste, which is comparatively of lesser strength, may be discharged in a fresh condition into the sewers to the extent of 3-5 % of the domestic sewage. The strong acidic or putrefied brewery waste will disrupt the normal biological activities of the waste treatment plants. For the sake of safe the brewery waste, if discharged into the sewers must be screened & pre treated by lime. The very high BOD content of the distilled waste makes it non amenable to the aerobic biological treatment and as such it cannot be discharged into municipal sewerage system directly.

Brewery wastes being comparatively less strong can be treated by aerobic biological treatment, after screening and neutralization. Usually, the biological treatment is accomplished by two stage process for 90-94% BOD reduction. A flow sheet of one such brewery waste treatment plant employing high rate trickling filters is shown in fig. When sufficient land is available, the brewery waste may be used for broad irrigation after neutralization to utilize the fertilizing components of the waste.

The yeast sludge from distilleries which contains very high suspended solids & BOD & is rich in proteins, carbohydrates, vitamins may be treated separately for by product recovery. But in practice they are mixed & discharged along with the spent wash. Both closed anaerobic digestion & open anaerobic lagoon has been tried in India. A single stage digester is usually adopted for anaerobic treatment when land available is limited.

### **By product recovery**

The yeast sludge from the distilleries contains the degradation product of the dead yeast organic debris from the malts like proteins, fats, vitamins & carbohydrates. On the other hand the spent wash contains all the above nutrients unfermented sugars, amino acids, caramels, ammonium phosphate etc. here 2 types of byproduct. i.e., Nutrient rich animal feed & the potassium rich fertilizers may be recovered in distillery.

The segregation of yeast sludge for processing the animal feed is practiced in some distilleries which in turn reduces the insoluble BOD load of the waste.

Yeast powder of pharmaceutical grade can also be obtained from yeast sludge & spent wash mix, while the animal feed derived from the debris waste and from the spent wash of distillers is usually considered as useful cattle feed. Care should be taken in the use of animal feed derived from the spent wash of the molasses distilleries. The latter contains a large no of inorganic substances and produce a laxative effect on the cattle's. The repeated soaking of the liquid waste & drying under direct sunlight produces a very good feed for fish.

Whatever may be the desired by product, the liquid waste is first screened, evaporated & then dried distillery waste. The evaporating & concentration of soluble wastes is accomplished in different types of evaporates. The concentrated waste is then dried on conventional spray & drum driers. This product is known as dried distillery soluble (DDS) which is normally used as an animal feed. The DDS can further be incinerated in health (at temp not exceeding  $700^{\circ}\text{C}$ ) to produce in organic ash rich in potassium salts can be further be purified by sequence of operations like leaching, filtration, & acidifying by sulphuric acid. It is further concentrated in vacuum evaporates and finally crystallization of KCL and sulphates is done. It may be noted that, the condensing water arising out of the process of evaporation of spent wash still contains a high BOD & should be treated before its disposal.

### 5.9 Recommended Questions

1. Explain the manufacturing process of the following industry with neat flow chart. Also mention the effect of effluent when discharged into the stream/sewer.
  - a. cotton and textile industry,
  - b. tanning industry,
  - c. cane sugar and distilleries,
  - d. dairy industry,
  - e. steel and cement industry
  - f. paper and pulp industry

### 5.10 Outcomes

1. Identify waste streams and design the industrial waste water treatment plant.
2. Manage sewage and industrial effluent issues.

### 5.11 Further Reading

1. <https://www.ecologixsystems.com/industry-dairy.php>
2. <http://textofvideo.nptel.ac.in/105106119/lec36.pdf>
3. <https://nptel.ac.in/courses/116104045/lecture1.pdf>
4. <https://nptel.ac.in/courses/103107088/module35/lecture1/lecture1.pdf>
5. <https://nptel.ac.in/courses/103107082/module5/lecture1/lecture1.pdf>